

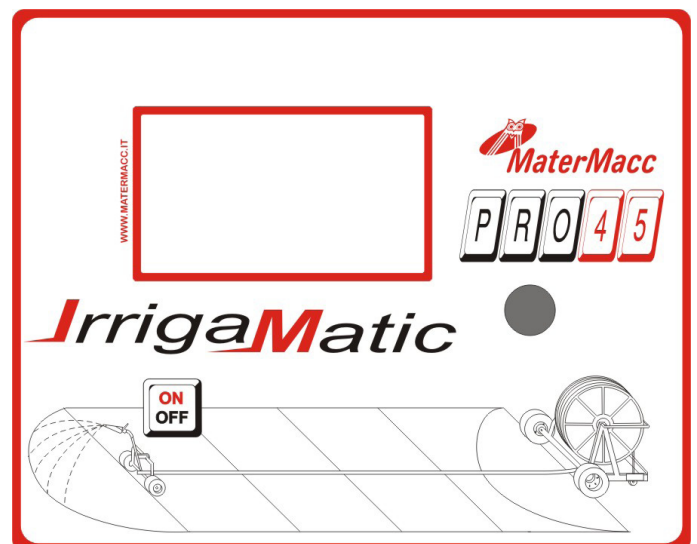

MaterMacc

ASSEMBLING INSTRUCTIONS

IRRIGAMATIC PRO 35 PRO 45

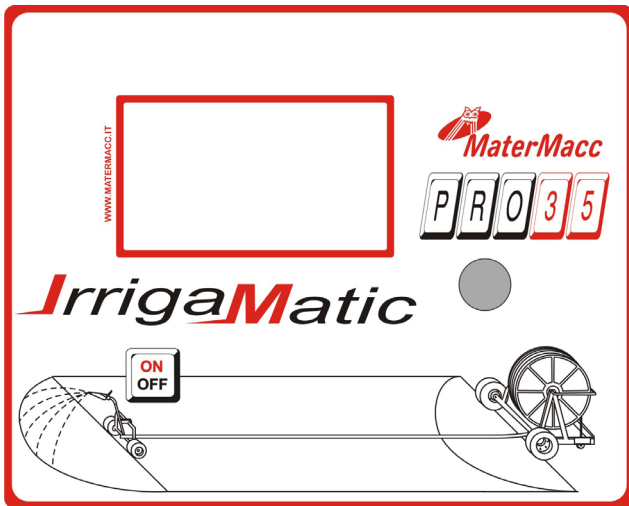

Carefully read this Handbook before using



Matermacc S.p.A.
Via Gemona, 18 - 33078 - San Vito al Tagliamento (PN) ITALIA
Telefono 0434/85267 telefax 0434/85517 www.matermacc.it e-mail info@matermacc.it

INTRODUCTION

This manual guide contains a description of the work and the necessary instructions for performing basic operations and regular maintenance of the device.

This guide is for convenience divided into easily-defined chapters.

These instructions are intended for professional users only, who are to possess specific knowledge about how to use the device, special admittance and training.

It is recommended to use original spare parts and accessories. Non-original parts in addition to forfeiture of the guarantee can be dangerous and may affect the durability and specifications of the machine.



This symbol indicates that it is necessary to pay maximum attention to the discussed issue.

It is possible that some devices, described in the manual, will not be present in your device, depending on the selected equipment and the intended market .

UPDATING THE MANUAL

Information, descriptions and illustrations contained herein shall reflect the state of the equipment at the time of its sale. The manufacturer reserves the right to perform from time to time possible changes in the equipment for technical or commercial reasons. Such changes do not require the Producer to intervene in sold up devices and do not render this publication inappropriate.

Possible additions the manufacturer finds necessary to provide in the future should be kept together with this manual guide and shall be an integral part thereof.

COPYRIGHT

Copyright on this manual is owned by the manufacturer of the equipment. This guide contains texts, drawings and technical schedule, which can not be released or transferred to a third party in whole or in part without the written permission of the manufacturer of the device.

WARRANTY

- Verify on delivery that the equipment has not been damaged during the transport and that the accessories are integral and complete.
- Any claims must be made in writing within 8 days from reception.
- The warranty against any defect of the materials is valid one year from the delivery date of the equipment.
- The warranty does not include shipment expenses (the material travels at risk and danger of the addressee).
- Any damage caused to people or things are excluded from the warranty.
- The warranty is limited to the repair or free replacement of the faulty piece.
- The retailers and the users are not entitled to any indemnification from the manufacturer for any damages (costs for work, transport, defective job, direct or indirect incidents, no profit on harvests, etc).

WARRANTY DECLINE

Besides what is reported in the supply contract the warranty declines:

- In case the limits referred to in the technical data table or in other tables in the handbook are exceeded.
 - In case the instructions described in this handbook have not been followed carefully.
 - In case of wrong use, faulty maintenance or mistakes made by the client.
 - In case of non original spare parts.
 - The contractual guarantee is not applied if the cited conditions are not respected even only partially.
 - The use of spare parts not approved by the Manufacturer invalidates every guarantee and releases the Manufacturer of Retailer from every liability due to malfunctioning or incidents.
 - The removal or modification of the shelters and protections releases the Manufacturer from every liability due to damages to things and/or people.
 - However, the Manufacturing Company is available to assure an immediate and accurate technical attendance and all that can be necessary for the better functioning maximum production of the equipment.
-

NOTES ON SAFETY

For the safe operation of the device first read carefully these notes.

Power supply

The device is designed for the specified type of current.

Maintenance

Maintenance procedures performed by the operator are described in the documentation supplied to the customer with the product.

Do not perform maintenance operations, which are not specified in the client documentation.

Cleaning

Before proceeding to cleaning, disconnect the power cord from the device.

Use specific multifunctional cleaning spray, since the use of other cleansers may result in breakage and possible incidents.

Electrical safety

Use only the power cord supplied with the equipment.

Do not place the unit where there is a chance of stepping on the power cord.

Do not put any objects on the device.

In the case of one of the below mentioned situations, immediately turn off the device and disconnect the power cord.

- The device produces noise or an unusual smell.
- Power cable is damaged or worn.
- Some liquid spilled into device.
- Any part of the device is damaged.

To resolve this issue, contact an authorized service center.

Operational safety

Do not perform maintenance procedures, if they are not described in the documentation, or no training was provided to the operator by the authorized regional dealer.

Always follow all warnings and instructions marked on the device or supplied with it.

Always pay utmost care when moving or transferring the device.

Always install the device in a spacious room, so you can perform the maintenance.

Do not place the device near a source of heat.

Recycling and processing

In accordance with European standards electrical and electronic devices should not be recycled together with domestic waste.

In the member states of the European Union you are to take electrical appliances to special places free of charge

.
For further information please contact the local agency responsible for recycling.

For further information, contact the local agency responsible for recycling, or ask for special instructions.

INDEX**INTRODUCTION****UPDATING THE MANUAL****COPYRIGHT****WARRANTY****WARRANTY DECLINE****NOTES ON SAFETY**

1. Electronic console installation.....	01
2. Installation of the speed sensor.....	02
2.1 Installing an inductive speed sensor on the pinion.....	02
2.2 Installation of the magnetic speed sensor with roller.....	02
3. Installation of the adjusting valve.....	03
3.1 Installation of the by-pass valve.....	03
3.2 Installation of a ball valve for piston irrigators.....	04
4. Installation of the end-of-work valve.....	05
4.1 Shunt valve.....	05
4.2 Slow-closing valve.....	05
5. Installation of the end-of-rewinding sensor.....	07
6. Options.....	07
6.1 Pressure switch installation.....	07
6.2 Outer alarm.....	08
7. Scheme.....	09
7.1 Irrigamatic PRO35 and PRO45 connection diagram.....	09
8. Instructions for use.....	10
8.1 Start up and main menu.....	10
8.2 How to access menu.....	10
9. Configuration.....	11
9.1 Loading procedure for configuration parameters.....	11
9.2 Parameters reserved to the manufacturer.....	12
10. Calibration.....	15

1 ELECTRONIC CONSOLE INSTALLATION

The electronic console must be installed on the irrigator frame in an accessible position, far from heat sources (for ex. engine) and away from vibrations.

It can be installed in a stainless steel optional protective case.

- Open the electronic console and bore the holes necessary to lead the cable through on the bottom and on the cable holder.
- Fix the electronic console bottom in the required position.
- Connect the motor cables and the sensor cables in their positions (see electric diagrams on pages 10-11) making sure not to make any mistakes.
- Connect the main cable bearing a ring with number **1** to terminal board **1**. Of the electronic console.

CHECK POLARITIES CONNECT RED CABLE WITH POLE + CONNECT BLACK CABLE WITH POLE -

- Fit the front and close the electronic console.
- **Connect the power supply cable to a 12V battery.**
- Fix the various cables by straps and cable holders.
- The system is now ready to operate.
- The average consumption of an Irrigamatic appliance is approx. 40-50 mA. This means that a 50 Ah battery should last approx 1000 h under normal conditions.
- Power supply to the battery can be obtained by an optional photovoltaic panel (OPTIONAL).

2 INSTALLATION OF THE SPEED SENSOR

2.1 INSTALLING AN INDUCTIVE SPEED SENSOR ON THE PINION

The inductive sensor has a maximum reading range of 4 mm and should be positioned on the bracket supplied in the kit, on the outlet pinion of the reduction gear, indifferently for crown or chain systems. Position the bracket and fix the sensor with nut and check nut at approx. 2 mm from pinion edge.

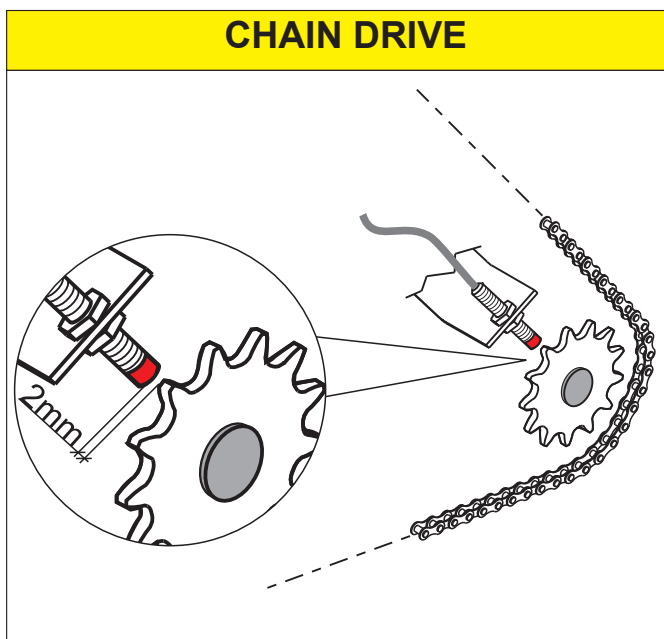
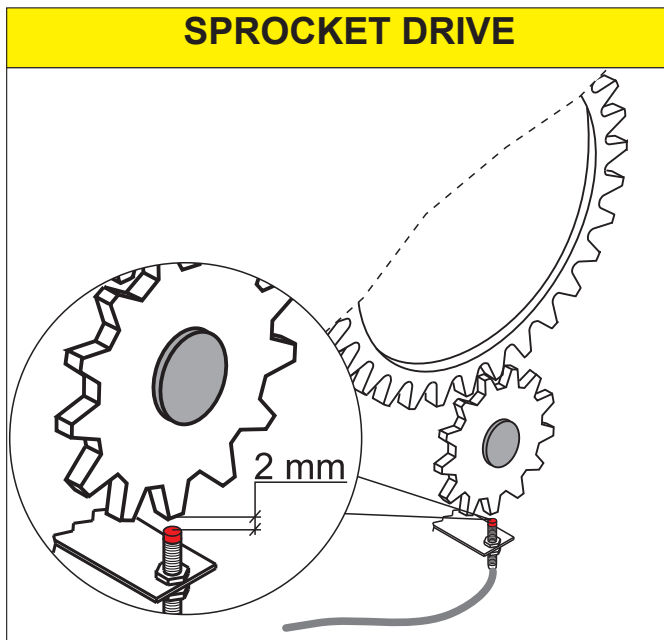

Should it be necessary to position the sensor on the crown, and should the crown not be perfectly circular, keep at higher distance. Then install a sensor with a wider reading range (optional up to 8mm)

Fix the sensor cable to the irrigator frame by straps or cable holders as far as the electronic gearcase.

The speed sensor cable bears a ring with number 2 and should be connected to gearcase connector 2, while the brown cable should be connected to the positive pole of terminal board 1 (electric diagram on page 9-10).



In the back side of the sensor there is a small light that turns on when the sensor detects the metal. Verify therefore, through this indication, that each tooth of the pinion is detected.

2.2 INSTALLATION OF THE MAGNETIC SPEED SENSOR WITH ROLLER

2.2.1 ROLLER INSTALLATION

The roller shall roll over the irrigation hose and shall be able to oscillate up and down in such a way as to keep in touch with the hose by its own weight.

The arm spacer shall be mounted upwards not to scratch the hose.

Connections can be welded or bolted on the hose guide. After mounting the roller, this shall be able to oscillate freely.

IMPORTANT: DO NOT PRESS ON THE ROLLER.

2.2.2 SENSOR INSTALLATION

- Insert the sensor in the arm hole from the magneto side and fix it with nut and check nut.
- Fix the spiralled cable to the roller arm and to the hose guide by straps or cable holders.
- Fix the cable to the irrigator frame, centrally over the hose guide in such a length as to allow the hose guide to slide from right to left with the cable still slightly twisted. Make sure the cable is in such a position as to avoid any damage during operation.
- For heavy duty conditions an optional speed sensor is available with a Rilsan cable.
- Fix the sensor cable to the irrigator frame by straps or cable holders as far as the electronic gearcase.
- The speed sensor cable bears a ring with number 2 and should be connected to gearcase connector 2.

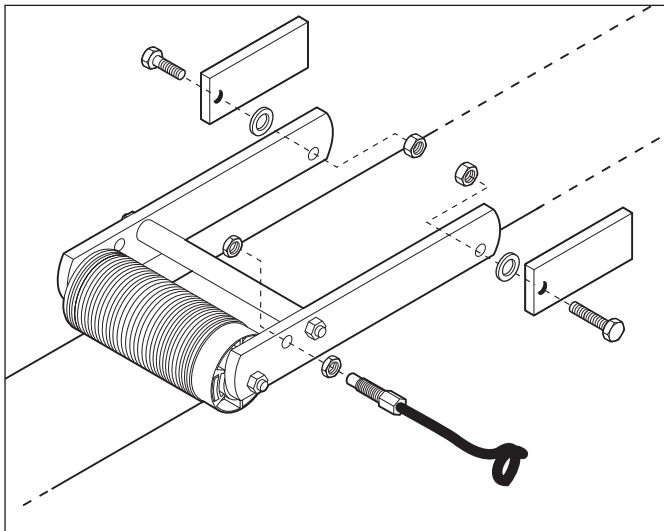

3. INSTALLATION OF THE ADJUSTING VALVE

3.1 INSTALLATION OF THE BY-PASS VALVE

3.1.1 BY-PASS VALVE INFORMATION

- The by-pass valve is used to send more or less water to the turbine, thus allowing to adjust the trolley return speed.
- The valve is sized according to the irrigator characteristics.
- The following table shows the size of the valve generally used according to the irrigation hose diameter:

irrigation hose	by-pass valve
50 - 100 mm	2"
80 - 110 mm	2" ½
100 - 125 mm	3"
130 - 140 mm	4"

When the by-pass valve is fully open, the hose rewinding speed is zero even when the hose is partially rewound. For this reason, under specific conditions, it may be useful to install valves in a size different from standard ones. By-pass valves consist of a 100mm long body with female gas threading at the ends and a head gasket for wafer mounting. A butterfly valve with an elastic rim is mounted inside. The motor reduction gear is fitted on the valve shaft. The motor reduction gear is controlled by the gearcase for speed adjustment.

3.1.2 HOW TO MOUNT THE BY-PASS VALVE

Fit the by-pass valve in the by-pass duct of the turbine in such a position as to prevent the motor reduction gear from getting upside down to prevent water seepage. The duct with the by-pass valve should not be rigid, but at least with a section of rubber or plastic hose to prevent any damage to the valve.

3.1.3 MOTOR REDUCTION GEAR INSTALLATION

Insert the motor reduction gear in the valve shaft in such a way as to position the shaft plug in the motor reduction gear seat. Insert the locking pin of the motor reduction gear in the slot of the valve body, then lock the unit by straps as shown in the figure below.

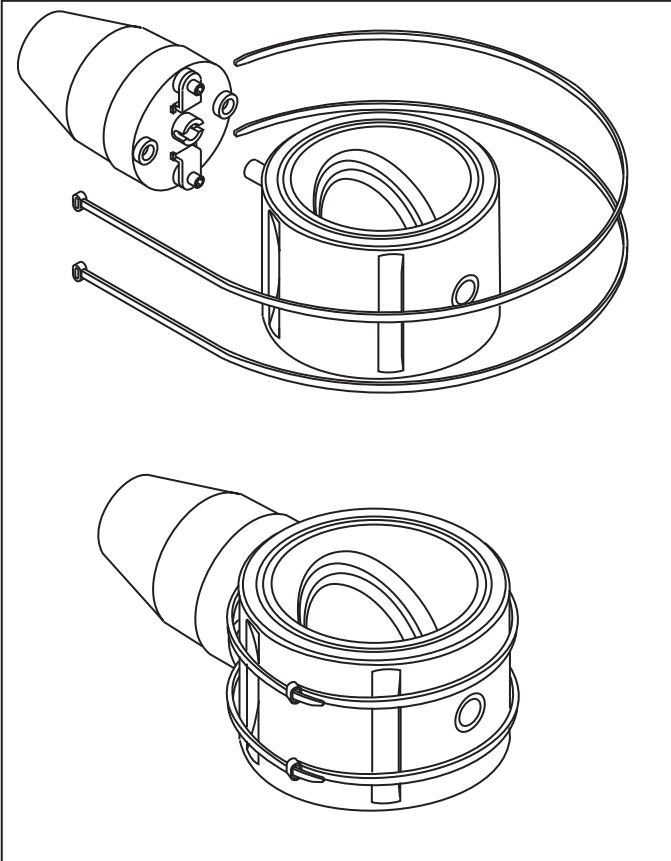

Fix the motor reduction gear cable to the irrigator frame by straps or cable holders as far as the electronic gearcase.

The motor reduction gear cable bears a ring with number 4 and should be connected to gearcase connector 4.

3.2 INSTALLATION OF A BALL VALVE FOR PISTON IRRIGATORS

The rewinding speed adjustment for piston irrigators is obtained by means of a ball valve ($\frac{3}{4}$ "") with a female to female threading on which the motor reduction gear is applied.

The ball head valve is preferably installed in the delivery hose taking water to the piston, but it can be installed in the water drain as well.

For installation follow the instructions given for by-pass valve installation.



Each valve is supplied with a manual adjustment dial that can be very useful should the adjustment system be out of order, in that it permits to keep the valve approx. in a working position anyway.

4 INSTALLATION OF THE END-OF-WORK VALVE

4.1 SHUNT VALVE

The shunt valve is a 3-way motor-driven valve used to pilot a hydraulic valve to discharge pressure from the duct and stop the irrigation cycle. Choose the position for the shunt valve and fix it with its support vertical by two screws.

Fix the 3-way valve motor cable to the irrigator frame by straps or cable holders as far as the electronic gearcase. The 3-way valve motor cable bears a ring with number 5 and should be connected to gearcase connector 5.

Connect the shunt valve to the hydraulic valve as shown in the diagram below.

The hydraulic valve is usually fitted on the hose to the drain.

To connect the shunt valve to the hydraulic valve, use a plastic hose (6 or 8mm diameter) and fittings.

The shunt valve is a threaded 1/8" female.

Upon request a 5-way valve can be supplied to control a double-acting piston.

4.1.1 DIAGRAM OF THE HYDRAULIC VALVE TO THE DRAIN

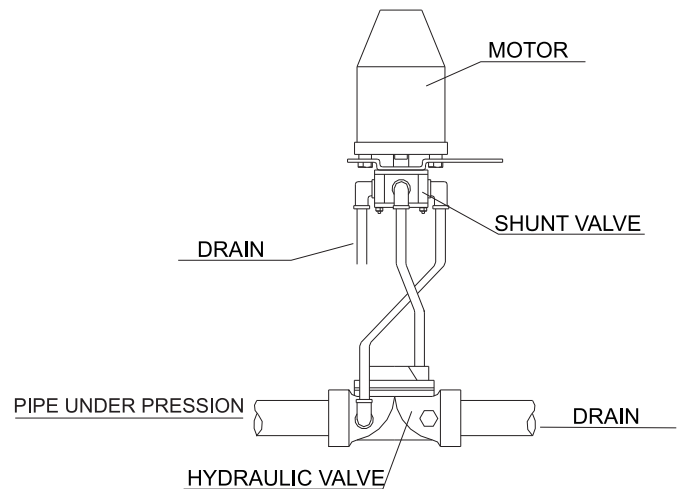

4.2 SLOW-CLOSING VALVE

The slow-closing valve consists of a motor-driven butterfly valve. It can be mounted on the inlet (closing in approx. 4 minutes) to close the water delivery to the irrigator or on the drain (opening in approx. 1,5 minutes) to let pressure drop.

Two types of motor reduction gears are mounted:

- one for valves (diameter up to 3")
- one for valves (diameter of 4" and over) (with an extra reduction gear).

4.2.1 HOW TO MOUNT THE BUTTERFLY VALVE

Fit the valve in the inlet or outlet duct to prevent the motor reduction gear from capsizing and avoiding water seepage.

4.2.2 MOTOR REDUCTION GEAR INSTALLATION

Fit the motor reduction gear in the valve square shaft and fix it to the valve body by means of 4 screws (see figure).

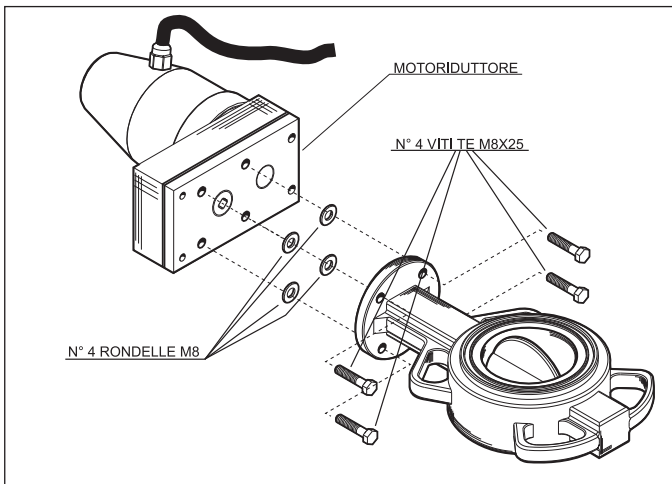
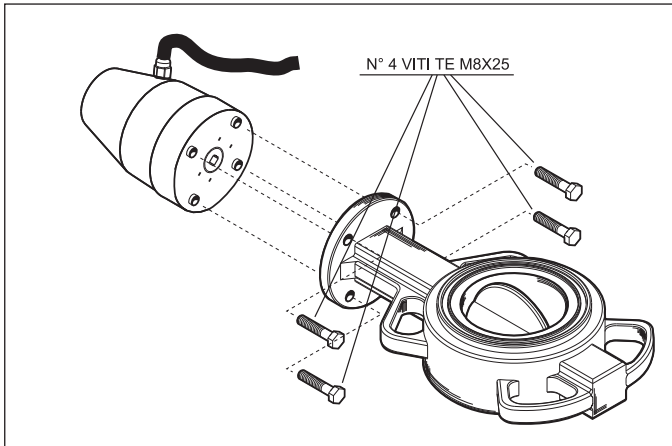

- Fix the valve motor cable to the irrigator frame by straps or cable holders as far as the electronic gearcase.
- **The valve motor cable bears a ring with number 5 and should be connected to gearcase connector 5.**

5 INSTALLATION OF THE END-OF-REWINDING SENSOR

The end-of-rewinding sensor is used to give the gearcase consent to start the procedures of end-of-work once the whole hose has been rewound.

Fix the magnet on the transmission rod at a maximum distance of 5 mm in front of the sensor.

The sensor should be fixed on the frame by means of a bracket to obtain the above described condition.

Make sure the distances are complied with and the magnet passes close to the sensor tip without damaging it.

Fix the end-of-rewinding sensor cable to the irrigator frame by straps or cable holders as far as the electronic gearcase.

The end-of-rewinding sensor cable bears a ring with number 3 and should be connected to gearcase connector 3.

6 OPTIONS

6.1 PRESSURE SWITCH INSTALLATION

The Irrigamic machines are preset for direct connection to the electronic gearcase of a pressure switch used to inform the system about any leak of pressure in the duct. The supplied pressure switch has a male threaded 1/8" connection. The pressure switch should be installed at the top of the duct to prevent impurity from depositing on the bulb.

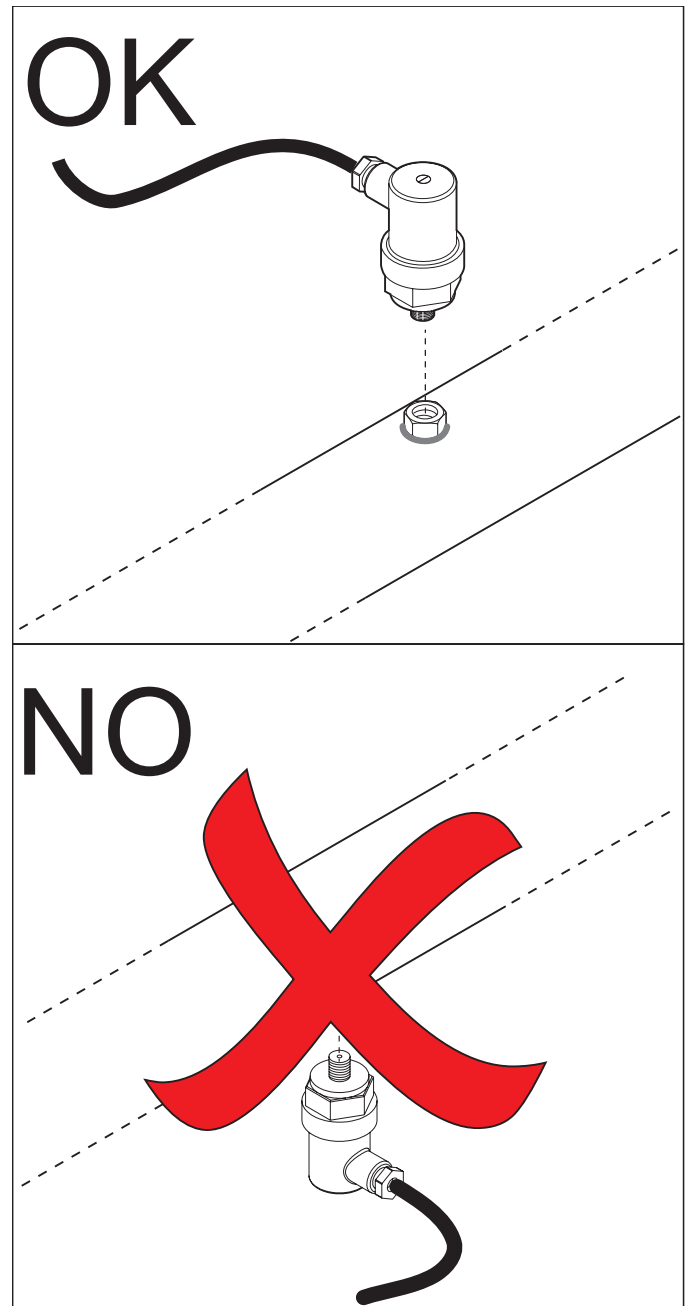

6.1.1 HOW TO CALIBRATE THE PRESSURE SWITCH

Upon supply, pressure switch calibration is random. To modify this value, remove the cover and act on the screw fitted on the pressure switch.

Tighten the screw to increase pressure, loosen the screw to reduce it.

The contacts are normally closed and open when the operating pressure is higher than the preset pressure.

The pressure switch cable bears a ring with number 7 and should be connected to gearcase connector 7.

6.2 OUTER ALARM

In PRO35 - PRO45 models (preset appliances) an outer alarm (beeper, flashing light or other) the power supply of which is obtained directly from the battery.

It is controlled by an outer gearcase relay that can stand a maximum current of 5A. The relay contacts close after unwinding (if the sensor is installed) and, for one minute, at the end of the irrigation cycle, or in case of trouble.

The outer alarm system should be connected to connector 10.

7 SCHEME

7.1 IRRIGAMATIC PRO35 AND PRO45 CONNECTION DIAGRAM

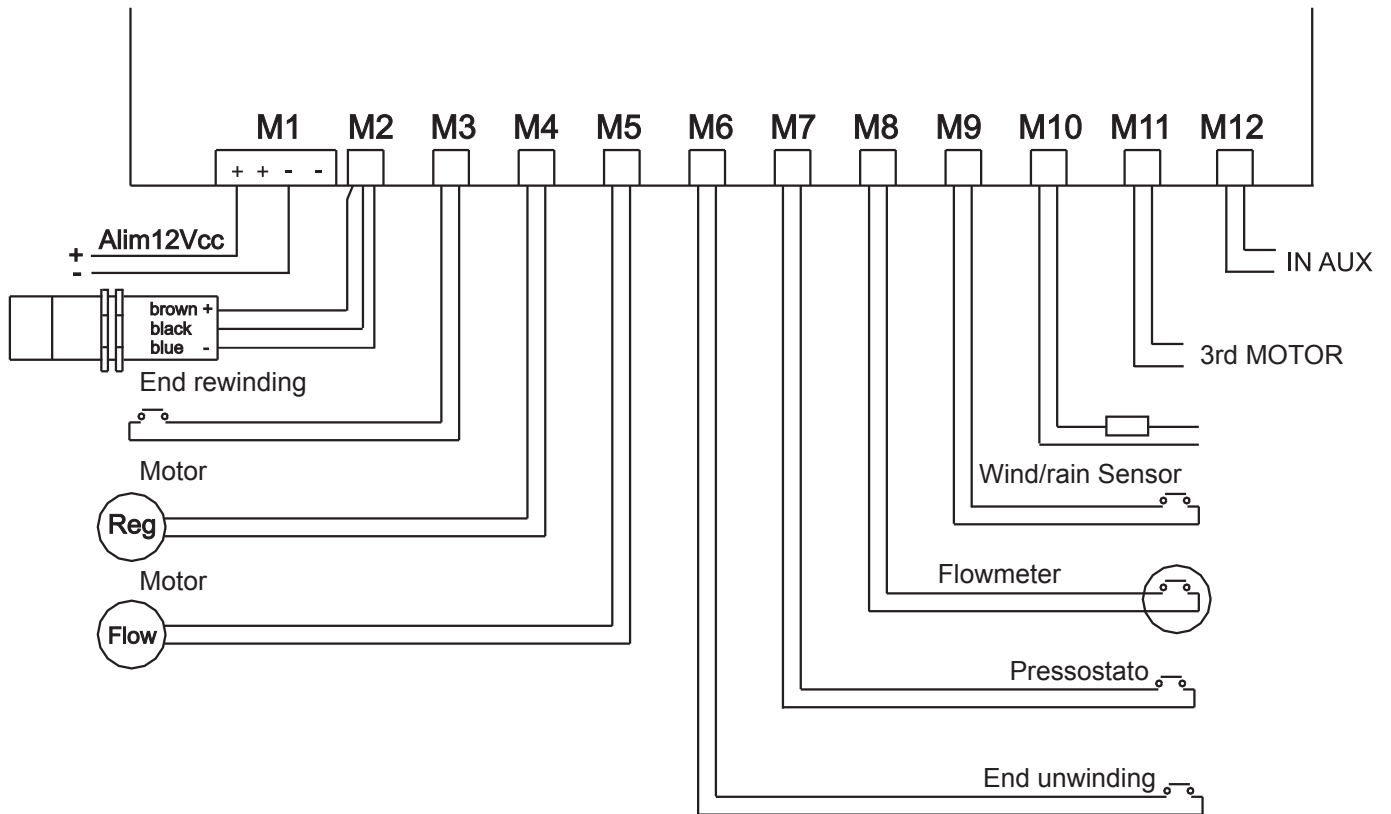

- 1 - POWER SUPPLY: 12 Vcc
- 2 - INDUCTIVE PROXIMITY SPEED SENSOR (PINION)
- 3 - END-OF-REWINDING SENSOR
- 4 - SPEED ADJUSTMENT MOTOR: 12Vcc
- 5 - END-OF-WORK VALVE MOTOR: 12Vcc
- 6 - END-OF-UNWINDING SENSOR (OPTIONAL)
- 7 - PRESSURE SWITCH (OPTIONAL)
- 8 - PULSE FLOWMETER (5 - 180 pulses/ litre)
- 9 - WIND/RAIN SENSOR
- 10 - CONTACT FOR FLASHING LIGHT/RADIO SIGNAL, etc. (maximum charge 5A)
- 11 - AUXILIARY IRRIGATOR MOTOR VALVE
- 12 - AUXILIARY MOVEMENT SENSOR

**MAGNETIC SPEED SENSOR
CONNECTOR WIRING**

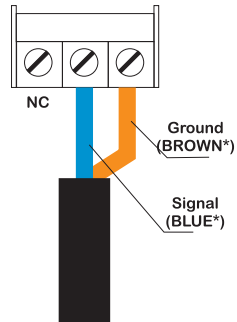

* Color is indifferent (NOT polarized)

USED IN CASE OF SPEED SENSOR
ON ROLLER

**INDUCTIVE SPEED SENSOR
CONNECTOR WIRING**

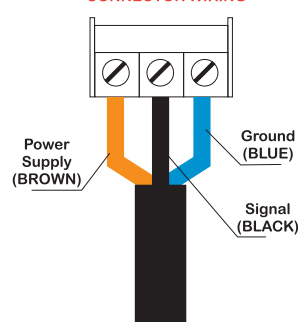

USED IN CASE OF SPEED SENSOR
ON GEAR WHEEL

8 INSTRUCTIONS FOR USE

8.1 START UP AND MAIN MENU

1. Connect power supply cables of electronic console to a 12V d.c. voltage source.
2. When switching electronic console on the LCD will display name and version of its firmware.
3. A series of messages follow:

The first message informs about the execution of the initialization.

1) FLUX OPEN

A second message: the BYP valve opens to make sure the start speed is set to zero.

2) BYP OPEN

A third message: closing of the aux irrigator (if present on the machine)

3) AUX CLOSE

INIT COMPLETE

4. The electronic console goes to main screen waiting for new commands from the user who can access the menus listed below:

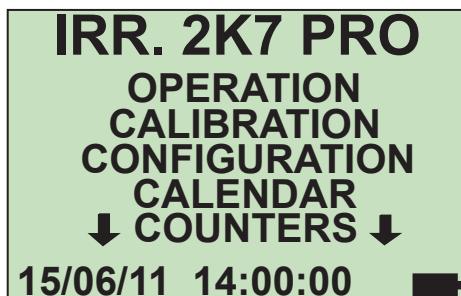

8.2 HOW TO ACCESS MENU (General Procedure)

To access menu and parameters to set-up the console you ave to perform only three actions:

- Turn clockwise (cw): to scroll-up a menu, to increase a parametr's value, to focus an edita-ble value o a software key i.e "NEXT", "BACK", etc.

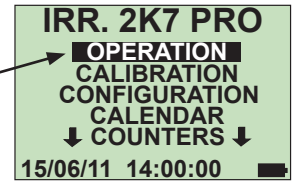

- Push the knob to confirm and access the desired menu.



PASSWORD protected menu

- If the menu is password-protected, the label "PASSWORD" appears, under which the characters making up the necessary password must be entered.

- Push the knob: the first character will become "0**", meaning that the character is now editable.
- Change the character by turning the knob cw or ccw.
- Confirm the selected character by Pushing the knob.
- Position the focus on the next space by turning the knob cw or ccw.
- Repeat steps b) to d) until the last character has been entered, then position the focus on NEXT and push the knob.

- If the password is correct the console will show the first value of the menu parameter; otherwise, it will remain at the password menu.

- To exit this menu, position the focus on "ESC" and push the knob or focus "NEXT" and hold down the knob for 5s

9 CONFIGURATION





The IRRIGAMATIC gearcase requires programming the parameters needed to configure the device in view of the irrigator equipment and features.



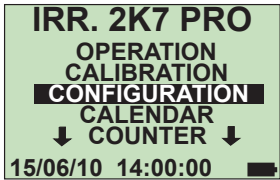

Possible mistakes in programming these parameters would jeopardize the operation of the irrigator badly.

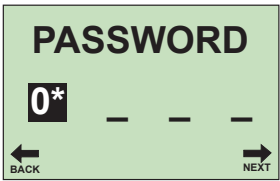
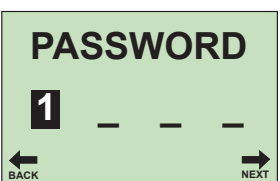
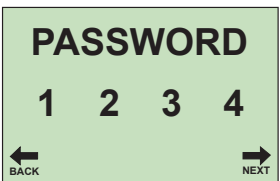
To prevent non-authorized people from changing these parameters by mistake the gearcase is password protected.

This access password is personalized for every manufacturer. It is entered by Matermacc and communicated only to the interested parties.

9.1 LOADING PROCEDURE FOR CONFIGURATION PARAMETERS

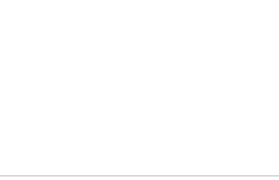
PRO35 - PRO45	
<ul style="list-style-type: none"> Position the FOCUS on the CONFIGURATION menu. Push the knob to confirm. 	
<ul style="list-style-type: none"> The display indicates whether the previous cycle has been completed. 	
<ul style="list-style-type: none"> Push the knob to confirm. The display indicates whether the previous cycle has been completed. 	
<ul style="list-style-type: none"> Modify the first code number by turning the knob and confirm by pressing the knob. The display will read for example: 	
<ul style="list-style-type: none"> Move the focus on to the second position and repeat 2 to 3 until the code has been completed. The following will be displayed, for ex.: 	
<ul style="list-style-type: none"> Highlight by turning the knob on it and press the knob 	

<ul style="list-style-type: none"> If the password is correct the following will be displayed: 	
<ul style="list-style-type: none"> To change the parameter value rotate the knob until the value is highlighted and press the knob. 	
<ul style="list-style-type: none"> Modify the value by turning the knob right or left and confirm by pressing the knob again the following will be displayed for ex.: 	
<ul style="list-style-type: none"> To scroll the parameters place the focus on the label. Push the knob to scroll the parameters 	
<ul style="list-style-type: none"> To exit from the configuration menu goto display <ESC>. Move the focus on the label and push the knob. To exit from configuration menu you can also: a) move the focus on "NEXT"; b) hold down the knob for about 5s: returns to main display 	

9.2 PARAMETERS RESERVED TO THE MANUFACTURER

Configuration parameters are described by the table below.

#	Description	Range	Default	MU
1	Position of flux valve Visible also to the end user (password 1111).	- Inlet - discharge	inlet	Flag
2	Timeout (opening phase) flux valve if inlet.	[30...360]	300	s
3	Timeout (closing phase) flux valve if inlet.	[30...360]	300	s
4	Timeout (opening phase) flux valve if discharge.	[30...360]	300	s
5	Timeout (closing phase) flux valve if discharge.	[30...360]	300	s
6	Pulsing opening phase duration of flux valve.	[30...360]	30	s
7	Pulsing closing phase duration of flux valve.	[30...360]	20	s
8	Multiplier of expected interval time between two pulses to start regulation by long pulses.	[0...360]	10	
9	Multiplier of expected interval times between two pulses to trigger a "lost gun cart" alarm.	[0...360]	25	
10	Timeout (opening phase) bypass valve.	[1...10]	60	s
11	Timeout (closing phase) bypass valve.	[10...200]	60	s
12	Time interval to perform the pressure check (in case of FLUX valve position (#1) set "inlet" and pressure-switch position (#13) set "downstream...")	[30...360]	10	min
13	Pressure-switch position	- none - downstream of flux valve – NO type - downstream of flux valve – NC type - upstream of flux valve – NO type - upstream of flux valve – NC type	none	
14	Speed sensor position	- on roller - on pinion	on pinion	
15	Pulse's decimator filter	[0...10]	0 if #14 = 0 2 if #14 = 1	
16	End unwinding sensor.	- absent - present	present	
17	End rewinding sensor.	- none - present	present	
18	Rain/wind sensor.	- none - present	none	
19	Regulation units	- m/h - mm H2O - free (user selectable)	m/h	
20	Measured average flux (need flow-meter). Visible only if #59 = 0 and #19 = 1.	[500...3000]	1000	l/min
21	Minimum value of flux (corresponding to 4 mA if analog flow-meter). Visible only if #59 = 0 and #19 = 1.	[500...3000]	600	l/min
22	Maximum value of flux (corresponding to 20 mA if analog flow-meter). Visible only if #59 = 0 and #19 = 1.	[500...3000]	2700	l/min
23	Symmetric dead band of measured flux for regulation (mmH2O units) Visible only if #59 = 0 and #19 = 1.	[0...100]	5	%





#	Description	Range	Default	MU
24	Conversion factor in case of "on roller speed" sensor (mm/pulse).	[5...250]	100	mm / pulse
45	hrs total counter	[0...10000]	0	hrs
46	hrs partial counter	[0...10000]	0	hrs
47	Measuring units Visible also to the end user (password 1111). EU (m, m/h, mm, mc/h,bar); UK (ft, ft/h, mil, UK gal/min,psi); US (ft, ft/h, mil, US gal/min,psi)	0 = EU 1 = UK 2 = US	EU	
48	Language	- italian - english - german - french - spanish - polish	italian	
49	Drum diameter (used in case of math calibration).	[500...2500]	1400	mm
50	Drum width (used in case of math calibration).	[1000...2500]	2000	mm
51	Hose diameter (used in case of math calibration).	[40...250]	140	mm
52	Hose length (used in case of math calibration).	[0...1500]	250	m
53A	Hose geometric vertical deformation (used in case of math calibration).	[-20...0]	0	%
53B	Hose geometric horizontal deformation (used in case of math calibration).	[0...20]	0	%
53C	Hose length deformation (used in case of math calibration).	[0...20]	0	%
53D	Single turn percentage used to compensate loss in hose winding on the drum (used in case of math calibration).	[0...60]	25	%
54	Drum turn pulses (used in case of math calibration).	[10...1000]	60	
55	Indicates the status of the GSM module. Only if GSM module enabled by factory. Visible also to the end user (password 1111).	- active - not active	not active	
57	Auto-shutoff timer (triggered if no any active process). Visible also to the end user (password 1111).	0...240 (0 = disabled)	0	min
58	Pulled out hose's length for GSM phonecall triggering. Visible also to the end user (password 1111).	[0...1500]	100	m
59	Constant water flux. Used as option if no flow-meter is available. Visible only if #19 = mmH2O. Visible also to the end user (password 1111).	[0...2700]	0	l/min
61	Hose length to retrieve to activate the auxiliary irrigator. Visible also to the end user (password 1111).	[0...1500]	250	m
62	Hose length to retrieve to deactivate the auxiliary irrigator. Ignored if parameter #63 > 0. Visible also to the end user (password 1111).	[0...1500]	250	m
63	Auxiliary irrigator shut-off timer. Used for timerized management of the aux irrigator. It has to be used in option to parameter #62. Visible also to the end user (password 1111).	[0...1440]	0	min
64	Pulled out hose length for auxiliary relay triggering. Visible also to the end user (password 1111).	[0...1500] (0 = disabled)	0	m
65A	Low pressure alarm override timer at irrigation start. When elapsed std delay alarm enable/disable is 5s. If #65=0 default value of 5s is assumed. If set to 0 the delay will be 5s. Visible also to the end user (password 1111).	[0...120]	0	min

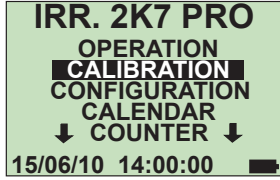
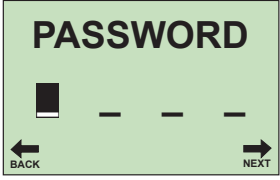

#	Description	Range	Default	MU
65B	Disable flux valve activation/deactivation in case of low pressure detection. Visible also to the end user (password 1111).	- NOT excluded - excluded	NOT excluded	
66	flow-meter type Visible only if #59 = 0 and #19 = 1.	- analog input type [5...1000] = digital (pulse input type)	0	l/pulse
67	Max delay timer between two pulses on auxiliary movement sensor (M12). If 0 the auxiliary movement sensor is disabled.	[0...60]	0	min

10 CALIBRATION

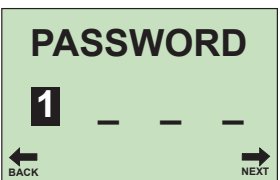
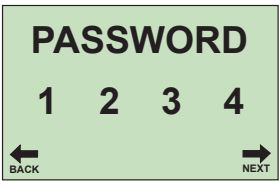
Accessible only if a machine with roll on pinion has been selected in configuration. The calibration menu is password protected. Accessible only through the passwords reserved to the irrigator's manufacturer.

10.1 LOADING PROCEDURE FOR CONFIGURATION PARAMETERS

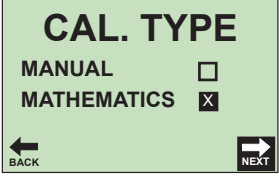
PRO35 - PRO45	
<ul style="list-style-type: none"> Position the FOCUS on the CALIBRATION menu. Push the knob to confirm. 	
<ul style="list-style-type: none"> The display changes to a input display. Now you have to enter the password. Move the focus on the first char (underscore). 	
<ul style="list-style-type: none"> Push the knob to confirm. The display will show. 	
<ul style="list-style-type: none"> Turn the knob to modify the value (0...9) of the first code and confirm by pushing the knob. The display will show for example. 	
<ul style="list-style-type: none"> Move the to the second char and repeat the previous operation for all remaining codes (at all you have to enter four codes) 	
<ul style="list-style-type: none"> Move the focus to  and push the knob 	

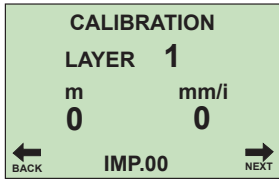
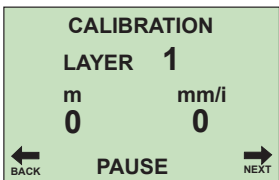
<ul style="list-style-type: none"> If the password is the right one the display will show 	
<ul style="list-style-type: none"> To select the type of calibration you will use (manual or mathematics) move the focus onto the check-box and push the knob 	
<ul style="list-style-type: none"> CALIBRATION TYPE (MATHEMATICS) The Irrigamic calculates the length and mm/i ratio for each layer 	
<ul style="list-style-type: none"> CALIBRATION TYPE (MANUAL) You have to enter length and mm/i ratio for each layer manually starting from the 1st layer (the most internal) To set the parameters move the focus to the input line. Push the knob to enter in "edit" mode Turn the knob to modify the value. Push the knob to confirm the value just entered. Move the focus to  . 	
<ul style="list-style-type: none"> Push the knob to go to the next layer. Repeat the above operation up to the last layer then focus on next Now you are on the 1st NON existing layer. Leave all blank and focus on next. Push the knob: the Irrigamic returns to the main display 	
<ul style="list-style-type: none"> NOTE: during a "on field calibration" you can suspend anytime you want the "capture of pulses" focusing on "IMP.xx" and pushing the knob. It will appear "PAUSE" 	

CALIBRATION PARAMETER TABLES

Manufactures..... **Model**.....

Serial Number..... **Date**.....

Mod. IRRIGAMATIC

PRO35

PRO45

Layer Number	PARAMETER	Layer length (m)	PPARAMETER	CONVERS. Mm/IMPULSE	Length read on the hose (m)
1	#25			#35	
2	#26			#36	
3	#27			#37	
4	#28			#38	
5	#29			#39	
6	#30			#40	
7	#31			#41	
8	#32			#42	
9	#33			#43	
10	#34			#44	



MaterMacc

Matermacc S.p.A.

Via Gemona, 18 - 33078 San Vito al Tagliamento (PN) ITALIA



0434/85267



0434/85517

www.matermacc.it - info@matermacc.it